



Multisensor

(Z-Wave 4-in-1 Sensor:

Motion, Temperature, Humidity, and Light Sensor)

Introduction:

The Aeotec Multisensor is a USB or battery-powered Z-Wave motion sensor, temperature sensor, humidity sensor, and lighting sensor all in one package. The sensor will send radio signals to up to 6 associated Z-Wave devices within its own Z-Wave network when the Motion Sensor detects IR changes in front of its viewing window.

Indoor/Outdoor functional tolerances allow the Aeotec Multisensor to function under weatherized conditions. Various sensitivity levels can be configured to avoid unintentional triggering from small animals such as cats and dogs.

By taking advantage of the Z-Wave mesh network, commands can be routed to their destination via intermediary "listening" Z-Wave products. Products that are Z-Wave certified can be used and communicate with other Z-Wave certified devices.

Package Contents:

- 1) Multisensor
- 2) Back-Mount Plate
- 3) Back-Mount Arm
- 4) USB AC Adapter
- 5) USB Cable
- 6) Screws (x2)

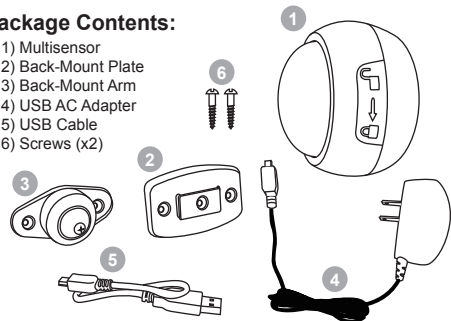

Important Disclaimer:

This product uses radio to wirelessly communicate data between itself and other devices. Radio communication is inherently not always 100% reliable, and as such, this product should not be used in situations in which life and/or valuables are solely dependent on its function.

Technical Specs

• Multisensor Physical Instructions:

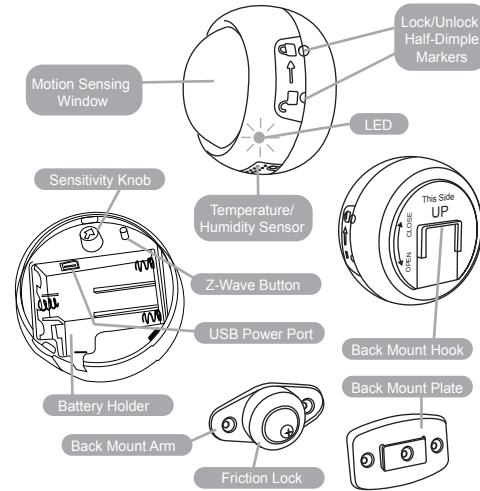

• Multisensor Power Instructions:

The Aeotec Multisensor has built in battery level detection. It will automatically report its battery level to the associated gateway throughout its life until the battery is fully drained and needs replacing. The battery status will often be displayed in the user interface of the gateway.

When used properly in an optimized Z-Wave network, operation via battery can function for 12 months before battery replacement.

- 1) Unlock the Multisensor from its battery cover by twisting the battery cover from the main unit in a counter-clockwise motion and pulling the battery cover outward to separate the main unit from the battery cover.

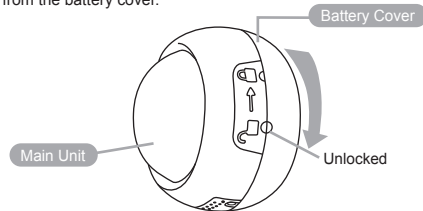

- 2) Insert 4 AAA batteries oriented according to the picture located in the battery holder (with the negative end depressing the battery spring).

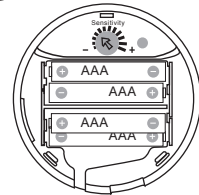

- 3) Lock the Multisensor main unit to its battery cover by aligning the Lock/Unlock Half-Dimple Markers under the "unlock" symbol and twisting the battery cover from the main unit in a clockwise motion until the Lock/Unlock Half-Dimple Markers form a circle under the "lock" symbol (a tangible click will be felt).

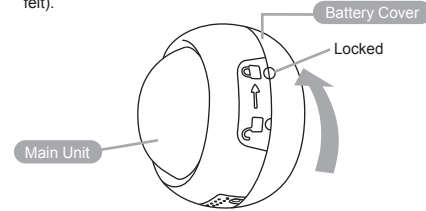

Recommendation: For networks which do not have a method to display the battery level of the Aeotec Multisensor, it is recommended that the sensor be tested occasionally to ensure that the battery still hold enough charge to operate. Batteries naturally lose their charge over time.

• Motion Sensor Effective Range:

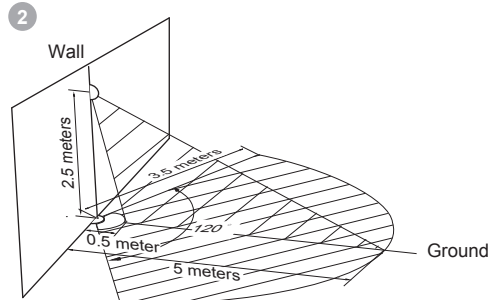
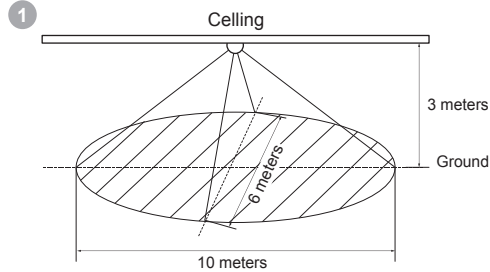

• Weatherization Orientation:

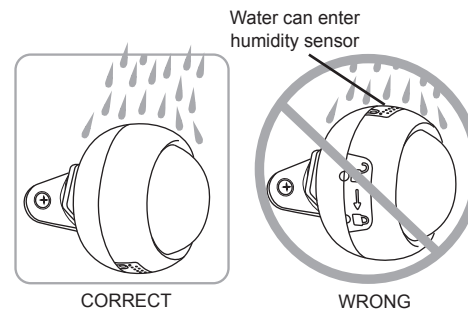

• Multisensor Physical Installation Instructions:

There are 2 methods to physically mount the Multisensor on the wall or ceiling. It can be mounted flat against the wall via the Back-Mount Plate or angled in a direction via the Back-Mount Arm.

Important: The Multisensor is weatherized and can operate outdoors in rain and snow. Placed outdoors where directly exposed to rain and snow, the Multisensor should be oriented such that the Temperature/Humidity Sensor is facing downward and positioned on the bottom of the unit. (See the Weatherization Orientation section)

- 1) Mounting the Multisensor flat against the wall via the Back-Mount Plate.

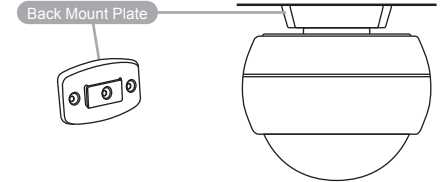

- 2) Mounting the Multisensor angled in a direction via the Back-Mount Arm.

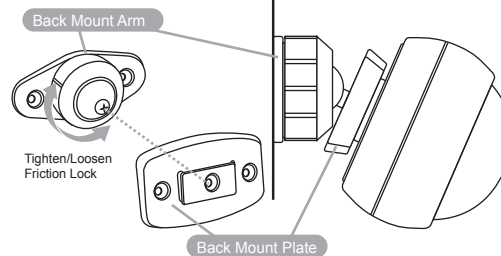

Note: The Back-Mount Arm may be locked in various angles by turning the Friction Lock clockwise and counter-clockwise to tighten or loosen (respectively) the angle of the arm.

Recommendation: For best performance, the Multisensor should NOT be mounted directly on or near metal framing or other large metallic objects. Large metal objects may weaken the radio signal transmitted.

• Adjusting the Sensitivity on the Multisensor

Turn the Sensitivity Knob in a clockwise direction to increase sensitivity and counter-clockwise to decrease sensitivity.

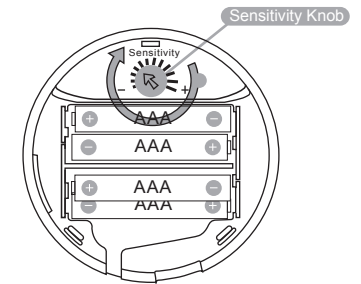



Harmonizing the Digital Home

Z-Wave Network Instructions:

The Aeotec Multisensor must be paired (included) into a Z-Wave network before it can send Basic Set Command, Temperature, Humidity, and Light level reports to association group 1, which is setup via the Association Command class. The Multisensor can only communicate to devices within it's own Z-Wave network.

Note: The LED on the Multisensor will blink if it is currently not paired into a Z-Wave network when pressing the Z-Wave Button.

Adding/Including/Pairing the Multisensor into a Z-Wave Network

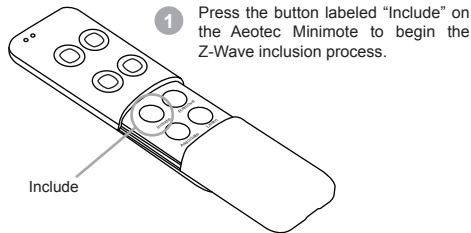

Note: To include the Multisensor with other controllers, please consult the operation manual for these controllers on how to include Z-Wave products into an existing network.

2 Press the Z-Wave Button under the Battery Cover to begin the Z-Wave pairing process.

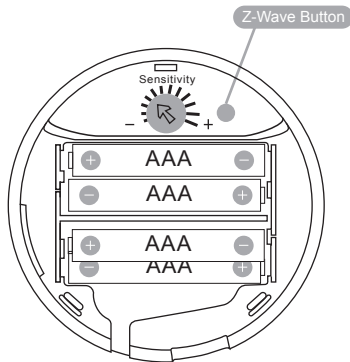

Troubleshooting: If the Multisensor was not successfully paired into any Z-Wave network, the LED which is on the Multisensor will blink when pressing the Z-Wave Button. If the Multisensor was successfully paired into a Z-Wave network, the LED will stay solid for a few seconds when pressing the Z-Wave Button.

Removing/Resetting the Multisensor from your Z-Wave Network

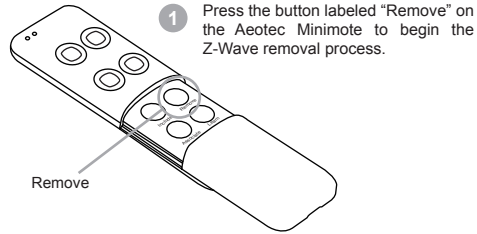

Note: To remove the Multisensor from other controllers, please consult the operation manual for these controllers on how to remove Z-Wave products from an existing network.

Troubleshooting: If the Multisensor was successfully removed from the Z-Wave network, pressing the Z-Wave Button will blink the LED. If the Multisensor was not successfully removed from the Z-Wave network the LED will stay solid for a few seconds.

Monitoring Motion

The Multisensor can send Basic Set Command to association group 1, which is setup via the Association Command Class, when Motion Sensor detects a motion to control the associated devices to "OPEN" state. After 4 minutes by default, if the Motion Sensor is not triggered again, the Multisensor will send Basic Set Command to these devices to control them to "CLOSE" state, but if the Motion Sensor is triggered again in 4 minutes, the Multisensor will reset the timing, and start to timing again.

The 4 minutes delay time can be changed through the usage of Z-Wave command built into Z-Wave certified controllers/gateways. (The specific Z-Wave command supporting this function is Configuration Command Class) Please consult the operation manual for these controllers/gateways for specific instructions on setting the Multisensor.

Monitoring Temperature, Humidity and Luminance

The Multisensor can report temperature, humidity, and luminance to a Z-Wave gateway or controller when requested. If this function is supported by the gateway/controller, the data will be displayed in the user interface of the gateway/controller. (The specific Z-Wave command supporting the monitoring is the Multilevel Sensor Command Class and Multi Channel Command Class. Automatic reports are sent to association group 1, which is setup via the Association Command Class.) Please consult the operation manual for these gateways/controllers for specific instructions on setting the Multisensor.

Warranty

Aeon Labs warrants to the original purchaser of Products that for the Warranty Period (as defined below), the Products will be free from material defects in materials and workmanship. The foregoing warranty is subject to the proper installation, operation and maintenance of the Products in accordance with installation instructions and the operating manual supplied to Customer. Warranty claims must be made by Customer in writing within thirty (30) days of the manifestation of a problem. Aeon Labs' sole obligation under the foregoing warranty is, at Aeon Labs' option, to repair, replace or correct any such defect that was present at the time of delivery, or to remove the Products and to refund the purchase price to Customer.

The "Warranty Period" begins on the date the Products is delivered and continues for 12 months.

Any repairs under this warranty must be conducted by an authorized Aeon Labs service representative and under Aeon Labs' RMA policy. Any repairs conducted by unauthorized persons shall void this warranty.

Excluded from the warranty are problems due to accidents, acts of God, civil or military authority, civil disturbance, war, strikes, fires, other catastrophes, misuse, misapplication, storage damage, negligence, electrical power problems, or modification to the Products or its components.

Aeon Labs does not authorize any person or party to assume or create for it any other obligation or liability in connection with the Products except as set forth herein.

Aeon Labs will pass on to Customer all manufacturers' Material warranties to the extent that they are transferable, but will not independently warrant any Material.

Customer must prepay shipping and transportation charges for returned Products, and insure the shipment or accept the risk of loss or damage during such shipment and transportation. Aeon Labs will ship the repaired or replacement products to Customer freight prepaid.

Customer shall indemnify, defend, and hold Aeon Labs and Aeon Labs' affiliates, shareholders, directors, officers, employees, contractors, agents and other representatives harmless from all demands, claims, actions, causes of action, proceedings, suits, assessments, losses, damages, liabilities, settlements, judgments, fines, penalties, interest, costs and expenses (including fees and disbursements of counsel) of every kind (i) based upon personal injury or death or injury to property to the extent any of the foregoing is proximately caused either by a defective product (including strict liability in tort) or by the negligent or willful acts or omissions of Customer or its officers, employees, subcontractors or agents, and/or (ii) arising from or relating to any actual or alleged infringement or misappropriation of any patent, trademark, mask work, copyright, trade secret or any actual or alleged violation of any other intellectual property rights arising from or in connection with the products, except to the extent that such infringement exists as a result of Aeon Labs' manufacturing processes.

IN NO EVENT SHALL AEON LABS BE LIABLE FOR ANY INDIRECT, INCIDENTAL, PUNITIVE, SPECIAL OR CONSEQUENTIAL DAMAGES, OR DAMAGES FOR LOSS OF PROFITS, REVENUE, OR USE INCURRED BY CUSTOMER OR ANY THIRD PARTY, WHETHER IN AN ACTION IN CONTRACT, OR TORT, OR OTHERWISE EVEN IF ADVISED OF THE POSSIBILITY OF SUCH DAMAGES. AEON LABS' LIABILITY AND CUSTOMER'S EXCLUSIVE REMEDY FOR ANY CAUSE OF ACTION ARISING IN CONNECTION WITH THIS AGREEMENT OR THE SALE OR USE OF THE PRODUCTS, WHETHER BASED ON NEGLIGENCE, STRICT LIABILITY, BREACH OF WARRANTY, BREACH OF AGREEMENT, OR EQUITABLE PRINCIPLES, IS EXPRESSLY LIMITED TO, AT AEOTEC'S OPTION, REPLACEMENT OF, OR REPAYMENT OF THE PURCHASE PRICE FOR THAT PORTION OF PRODUCTS WITH RESPECT TO WHICH DAMAGES ARE CLAIMED. ALL CLAIMS OF ANY KIND ARISING IN CONNECTION WITH THIS AGREEMENT OR THE SALE OR USE OF PRODUCTS SHALL BE DEEMED WAIVED UNLESS MADE IN WRITING WITHIN THIRTY (30) DAYS FROM AEON LABS' DELIVERY, OR THE DATE FIXED FOR DELIVERY IN THE EVENT OF NONDELIVERY.

THE INDEMNITY AND WARRANTY IN ABOVE ARE EXCLUSIVE AND IN LIEU OF ALL OTHER INDEMNITIES OR WARRANTIES, WHETHER EXPRESS OR IMPLIED, INCLUDING THE IMPLIED WARRANTIES OF MERCHANTABILITY AND FITNESS FOR A PARTICULAR PURPOSE.

FCC NOTICE (for USA):

THE MANUFACTURER IS NOT RESPONSIBLE FOR ANY RADIO OR TV INTERFERENCE CAUSED BY UNAUTHORIZED MODIFICATIONS TO THIS EQUIPMENT. SUCH MODIFICATIONS COULD VOID THE USER'S AUTHORITY TO OPERATE THE EQUIPMENT.

STORE INDOORS WHEN NOT IN USE. SUITABLE FOR DRY LOCATIONS. DO NOT IMMERSE IN WATER. NOT FOR USE WHERE DIRECTLY EXPOSED TO WATER.

This device complies with Part 15 of the FCC Rules. Operation is subject to the following two conditions:

1. This device may not cause harmful interference, and
2. This device must accept any interference received, including interference that may cause undesired operation. This equipment has been tested and found to comply with the limits for a Class B digital device, pursuant to part 15 of the FCC Rules. These limits are designed to provide reasonable protection against harmful interference in a residential installation. This equipment generates, uses and can radiate radio frequency energy and, if not installed and used in accordance with the instructions, may cause harmful interference to radio communications. However, there is no guarantee that interference will not occur in a particular installation. If this equipment does cause harmful interference to radio or television reception, which can be determined by turning the equipment off and on, the user is encouraged to try to correct the interference by one or more of the following measures:

- Reorient or relocate the receiving antenna.
- Increase the separation between the equipment and receiver.
- Connect the equipment into an outlet on a circuit different from that to which the receiver is connected.
- Consult the dealer or an experienced radio/TV technician for help.

Warning:

Do not dispose of electrical appliances as unsorted municipal waste, use separate collection facilities.

Contact your local government for information regarding the collection systems available.

Certifications (regional):

Do not dispose of electrical appliances as unsorted municipal waste, use separate collection facilities.

Contact your local government for information regarding the collection systems available.



www.aeon-labs.com

www.aeotec.com

